



6894S

40484

4

Hammer Drill

- MODEL HP1620
- MODEL HP1620F
- MODEL HP1621
- MODEL HP1621F

ENGLISH

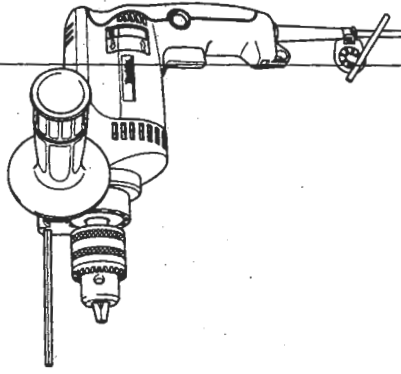

004358



DOUBLE INSULATION

INSTRUCTION

MANUAL

▲ WARNING:
 For your personal safety, READ and UNDERSTAND before using.
 SAVE THESE INSTRUCTIONS FOR FUTURE REFERENCE.

Makita Corporation

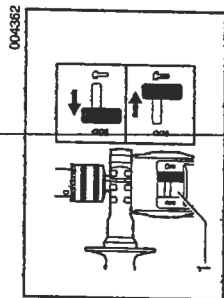

1. Action mode changing lever

ASSEMBLY

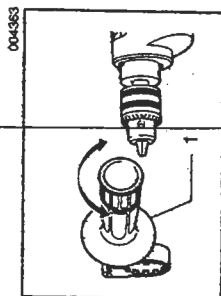

1. Side grip

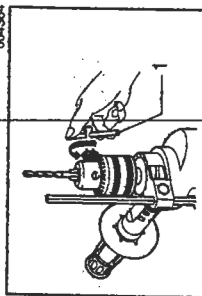

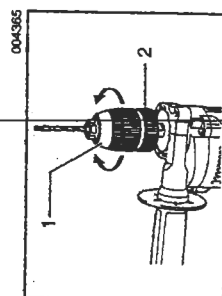

1. Chuck key



1. Sleeve
2. Ring

Selecting the action mode

This tool has an action mode change lever. For rotation with hammering, slide the action mode change lever to the right ( symbol). For rotation only, slide the action mode change lever to the left ( symbol).

⚠ CAUTION:

- Always slide the action mode change lever all the way to your desired mode position. If you operate the tool with the lever positioned halfway between the mode symbols, the tool may be damaged.

⚠ CAUTION:

- Always be sure that the tool is switched off and unplugged before carrying out any work on the tool.

Installing side grip (auxiliary handle)

Always use the side grip to ensure operating safety. Install the side grip on tool barrel.

Then tighten the grip by turning clockwise securely at the desired position. It may be swung 360° so as to be secured at any position.

NOTE:

- The side grip cannot swing 360° when the depth gauge is installed.

Installing or removing drill bit

For Model HP1620, HP1620F

To install the bit, place it in the chuck as far as it will go. Tighten the chuck by hand. Place the chuck key in each of the three chuck holes evenly. Be sure to tighten all three chuck holes evenly.

To remove the bit, turn the chuck key counterclockwise in just one hole, then loosen the chuck by hand.

After using the chuck key, be sure to return to the original position.

For Model HP1621, HP1621F

Hold the ring and turn the sleeve counterclockwise to open the chuck jaws. Place the bit in the chuck as far as it will go. Hold the ring firmly and turn the sleeve clockwise to tighten the chuck.

To remove the bit, hold the ring and turn the sleeve counterclockwise.

004380

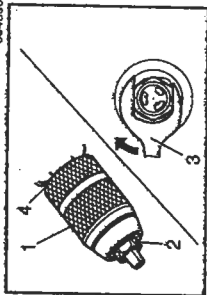

1. Sleeve
2. Hexagonal nut
3. Wrench 19
4. Retaining ring

NOTE:

- If the keyless drill chuck cannot be loosened because of a drill bit being caught inside the jaws of the chuck, loosen the drill chuck as follows.

- Hold the sleeve of the drill chuck firmly with water pump pliers or the like (Note: Do not hold the retaining ring portion.)
- Place the wrench 19, adjustable wrench or one of other appropriate wrenches on the hexagonal nut at the front of the drill chuck. Turn the wrench clockwise as shown in the figure to loosen the drill chuck.

Depth gauge

The depth gauge is convenient for drilling holes of uniform depth. Loosen the side grip and insert the depth gauge into the hole in the side grip. Adjust the depth gauge to the desired depth and tighten the side grip.

NOTE:

- The depth gauge cannot be used at the position where the depth gauge strikes against the tool body.

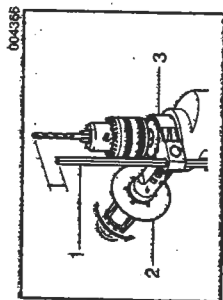

1. Depth gauge
2. Side grip
3. Grip base

OPERATION

Hammer drilling operation

⚠ CAUTION:

- There is a tremendous and sudden twisting force exerted on the tool/bit at the time of hole break-through, when the hole becomes clogged with chips and particles, or when striking reinforcing rods embedded in the concrete. Always use the side grip (auxiliary handle) and firmly hold the tool by both side grip and switch handle during operations. Failure to do so may result in the loss of control of the tool and potentially severe injury.

When drilling in concrete, granite, tile, etc., move the action mode changing lever to the position of  symbol to use "rotation with hammering" action.

Be sure to use a tungsten-carbide tipped bit.

Position the bit at the desired location for the hole, then pull the switch trigger. Do not force the tool. Light pressure gives best results. Keep the tool in position and prevent it from slipping away from the hole.

Do not apply more pressure when the hole becomes clogged with chips or particles. Instead, run the tool at an idle, then remove the bit partially from the hole. By repeating this several times, the hole will be cleaned out and normal drilling may be resumed.

001392

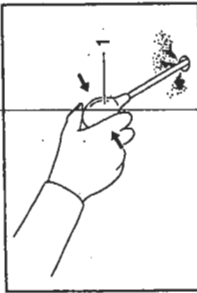

1. Blow-out bulb

Blow-out bulb (optional accessory)

After drilling the hole, use the blow-out bulb to clean the dust out of the hole.

Drilling operation

When drilling in wood, metal or plastic materials, move the action mode changing lever to the position of  symbol to use "rotation only" action.

Drilling in wood

When drilling in wood, the best results are obtained with wood drills equipped with a guide screw. The guide screw makes drilling easier by pulling the bit into the workpiece.

Drilling in metal

To prevent the bit from slipping when starting a hole, make an indentation with a center-punch and hammer at the point to be drilled. Place the point of the bit in the indentation and start drilling. Use a cutting lubricant when drilling metals. The exceptions are iron and brass which should be drilled dry.

CAUTION:

- Pressing excessively on the tool will not speed up the drilling. In fact, this excessive pressure will only serve to damage the tip of your bit, decrease the tool performance and shorten the service life of the tool.
 - There is a tremendous force exerted on the tool/bit at the time of hole break through. Hold the tool firmly and exert care when the bit begins to break through the workpiece.
 - A stuck bit can be removed simply by setting the reversing switch to reverse rotation in order to back out. However, the tool may back out abruptly if you do not hold it firmly.
 - Always secure small workpieces in a vise or similar hold-down device.
- When drilling in wood, metal or plastic materials, turn the action mode changing lever to the position of  symbol to use "rotation only" action.

MAINTENANCE

CAUTION:

- Always be sure that the tool is switched off and unplugged before attempting to perform inspection or maintenance.
- To maintain product SAFETY and RELIABILITY, repairs, carbon brush inspection and replacement, any other maintenance or adjustment should be performed by Makita Authorized Service Centers, always using Makita replacement parts.

FUNCTIONAL DESCRIPTION

CAUTION:

- Always be sure that the tool is switched off and unplugged before adjusting or checking function on the tool.

Switch action

CAUTION:

- Before plugging in the tool, always check to see that the switch trigger actuates properly and returns to the "OFF" position when released.
- To start the tool, simply pull the switch trigger. Tool speed is increased by increasing pressure on the switch trigger. Release the switch trigger to stop. For continuous operation, pull the switch trigger and then push in the lock button.
- To stop the tool from the locked position, pull the switch trigger fully, then release it.

004359

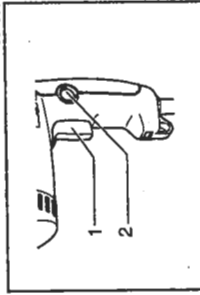
1. Switch trigger
2. Lock button

Lighting up the lamps

For Model HP1620F, HP1621F

CAUTION:

- Do not look in the light or see the source of light directly.
- To turn on the lamp, pull the trigger. Release the trigger to turn it off.

NOTE:

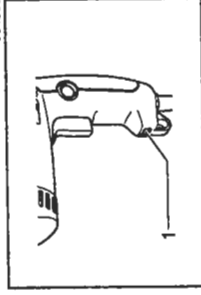

- Use a dry cloth to wipe the dirt off the lens of lamp. Be careful not to scratch the lens of lamp, or it may lower the illumination.
- Never use gasoline or thinner to clean the lens of the lamp, or it will be damaged.

004360





1. Lamp

Reversing switch action

This tool has a reversing switch to change the direction of rotation. Move the reversing switch to the  position (A side) for clockwise rotation or the  position (B side) for counterclockwise rotation.

CAUTION:

- Always check the direction of rotation before operation.
- Use the reversing switch only after the tool comes to a complete stop.
- Changing the direction of rotation before the tool stops may damage the tool.
- If the switch trigger can not be depressed, check to see that the reversing switch is fully set to position  (A side) or  (B side).

004361

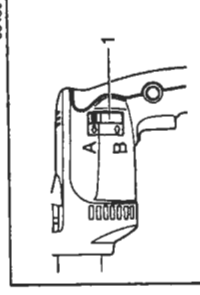

1. Reversing switch

ADDITIONAL SAFETY RULES FOR TOOL

ENB002-1

1. Hold tools by insulated gripping surfaces when performing an operation where the cutting tool may contact hidden wiring or its own cord. Contact with a "live" wire will make exposed metal parts of the tool "live" and shock the operator.
2. Always be sure you have a firm footing. Be sure no one is below when using the tool in high locations.
3. Hold the tool firmly with both hands. Always use the side grip.
4. Keep hands away from rotating parts.
5. Do not leave the tool running. Operate the tool only when hand-held. Do not touch the bit or the workpiece immediately after operation; they may be extremely hot and could burn your skin.

SAVE THESE INSTRUCTIONS

ACCESSORIES

⚠ CAUTION:

- These accessories or attachments are recommended for use with your Makita tool specified in this manual. The use of any other accessories or attachments might present a risk of injury to persons. Only use accessory or attachment for its stated purpose.

If you need any assistance for more details regarding these accessories, ask your local Makita service center.

- Tungsten-carbide tipped hammer bit
- Chuck key
- Hole saw
- Grip assembly
- Blow-out bulb
- Depth gauge
- Safety goggles
- Plastic carrying case
- Keyless drill chuck 13

SAFETY INSTRUCTIONS

⚠ WARNING:

When using electric tools, basic safety precautions, including the following, should always be followed to reduce the risk of fire, electric shock and personal injury. Read all these instructions before operating this product and save these instructions.

For safe operations:

1. **Keep work area clean.**
Cluttered areas and benches invite injuries.
2. **Consider work area environment.**
Do not expose power tools to rain. Do not use power tools in damp or wet locations. Keep work area well lit. Do not use power tools where there is risk to cause fire or explosion.
3. **Guard against electric shock.**
Avoid body contact with earthed or grounded surfaces (e.g. pipes, radiators, ranges, refrigerators).
4. **Keep children away.**
Do not let visitors touch the tool or extension cord. All visitors should be kept away from work area.
5. **Store idle tools.**
When not in use, tools should be stored in a dry, high or locked up place, out of reach of children.
6. **Do not force the tool.**
It will do the job better and safer at the rate for which it was intended.
7. **Use the right tool.**
Do not force small tools or attachments to do the job of a heavy duty tool. Do not use tools for purposes not intended; for example, do not use circular saws to cut tree limbs or logs.
8. **Dress properly.**
Do not wear loose clothing or jewellery, they can be caught in moving parts. Rubber gloves and non-skid footwear are recommended when working outdoors. Wear protecting hair covering to contain long hair.
9. **Use safety glasses and hearing protection.**
Also use face or dust mask if the cutting operation is dusty.
10. **Connect dust extraction equipment.**
If devices are provided for the connection of dust extraction and collection facilities ensure these are connected and properly used.
11. **Do not abuse the cord.**
Never carry the tool by the cord or yank it to disconnect it from the socket. Keep the cord away from heat, oil and sharp edges.
12. **Secure work.**
Use clamps or a vice to hold the work. It is safer than using your hand and it frees both hands to operate the tool.
13. **Do not overreach.**
Keep proper footing and balance at all times.
14. **Maintain tools with care.**
Keep cutting tools sharp and clean for better and

- safer performance. Follow instructions for lubrication and changing accessories. Inspect tool cord periodically and if damaged have it repaired by an authorized service facility. Inspect extension cords periodically and replace, if damaged. Keep handles dry, clean and free from oil and grease.
15. **Disconnect tools.**
When not in use, before servicing and when changing accessories such as blades/bits and cutters.
16. **Remove adjusting keys and wrenches.**
Form the habit of checking to see that keys and adjusting wrenches are removed from the tool before turning it on.
17. **Avoid unintentional starting.**
Do not carry a plugged-in tool with a finger on the switch. Ensure switch is off when plugging in.
18. **Use outdoor extension leads.**
When tool is used outdoors, use only extension cords intended for outdoor use.
19. **Stay alert.**
Watch what you are doing. Use common sense. Do not operate tool when you are tired.
20. **Check damaged parts.**
Before further use of the tool, a guard or other part that is damaged should be carefully checked to determine that it will operate properly and perform its intended function. Check for alignment of moving parts, free running of moving parts, breakage of parts, mounting and any other conditions that may affect its operation. A guard or other part that is damaged should be properly repaired or replaced by an authorized service center unless otherwise indicated in this instruction manual. Have defective switches replaced by an authorized service facility.
Do not use the tool if the switch does not turn it on and off.
21. **Warning.**
The use of any accessory or attachment, other than those recommended in this instruction manual or the catalog, may present a risk of personal injury.
22. **Have your tool repaired by a qualified person.**
This electric tool is in accordance with the relevant safety requirements. Repairs should only be carried out by qualified persons using original spare parts, otherwise this may result in considerable danger to the user.

SPECIFICATIONS

Model	HP1620/HP1620F/HP1621/HP1621F		
Capacities	Concrete	16 mm	
	Steel	13 mm	
	Wood	30 mm	
No load speed (min ⁻¹)	0 - 2,800		
Blows per minute	0 - 44,800		
Overall length	303 mm		
Net weight	1.7 kg		
Safety class	II		

• Due to our continuing programme of research and development, the specifications herein are subject to change without notice.

• Note: Specifications may differ from country to country.

SYMBOLS

The following show the symbols used for the tool. Be sure that you understand their meaning before use.



.....: Read instruction manual.



.....: DOUBLE INSULATION

Intended use

The tool is intended for impact drilling in brick, concrete and stone as well as for drilling without impact in wood, metal, ceramic and plastic.

Power supply

The tool should be connected only to a power supply of the same voltage as indicated on the nameplate, and can only be operated on single-phase AC supply. They are double-insulated in accordance with European Standard and can, therefore, also be used from sockets without earth wire.

For European countries only

Noise and Vibration

The typical A-weighted noise levels are

sound pressure level: 97 dB (A)

sound power level: 110 dB (A)

--Wear ear protection. --

The typical weighted root mean square acceleration value is 15 m/s².

EC-DECLARATION OF CONFORMITY

We declare under our sole responsibility that this product is in compliance with the following standards of standardized documents, HD400, EN50144, EN55014, EN61000 in accordance with Council Directives, 73/23/EEC, 89/336/EEC, 98/37/EC.

Yasuhiko Kanzaki CE 2002

Director

MAKITA INTERNATIONAL EUROPE LTD.

Michigan Drive, Tongwell, Milton Keynes, Bucks MK15 8JD, ENGLAND

Memo